

## Automotive-Grade Precision Mn-Cu Alloy Shunt Tightest Tolerance $\pm 0.5\%$ , Various Structure of Voltage Output Low thermal EMF & Power Coefficient

### Introduction

The ARCS series which targets automotive market can cover from hundreds to thousands of amperes. Due to special alloy materials, the ARCS series has good long-term stability and is capable to withstand pulse current several times, which is higher than the rated current.

Shunt resistance value and surface temperature will keep changing when loaded. The factors that cause the change in resistance include TCR and dimensional change caused by thermal expansion, etc. Shunt resistance tends to be stable when self-heating and heat dissipation reach dynamic balance, but high current coefficient will cause the change of shunt resistance greater than nominal tolerance. The special heat treatment process of the ARCS series make it a low current coefficient with very good compensation characteristics.

Because there is always a distance between the voltage sampling point and the resistor heating center, temperature difference is appeared, so a lower thermal EMF is particularly important. The ARCS series has thermal EMF of less than  $0.5\mu\text{V}/^\circ\text{C}$  to copper, and has little effect on the voltage output of the millivolt level. The flat structure of the ARCS series makes the inductance less than  $3\text{nH}$ , which also performs perfect at high frequency applications.

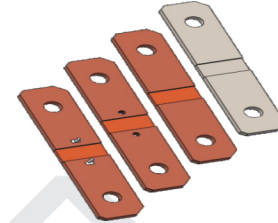

AEC-Q200 compliant



### Application

- Battery Management System
- Current Sensing
- Frequency Converter
- UPS
- Motor Control
- Electronic Load Equipment

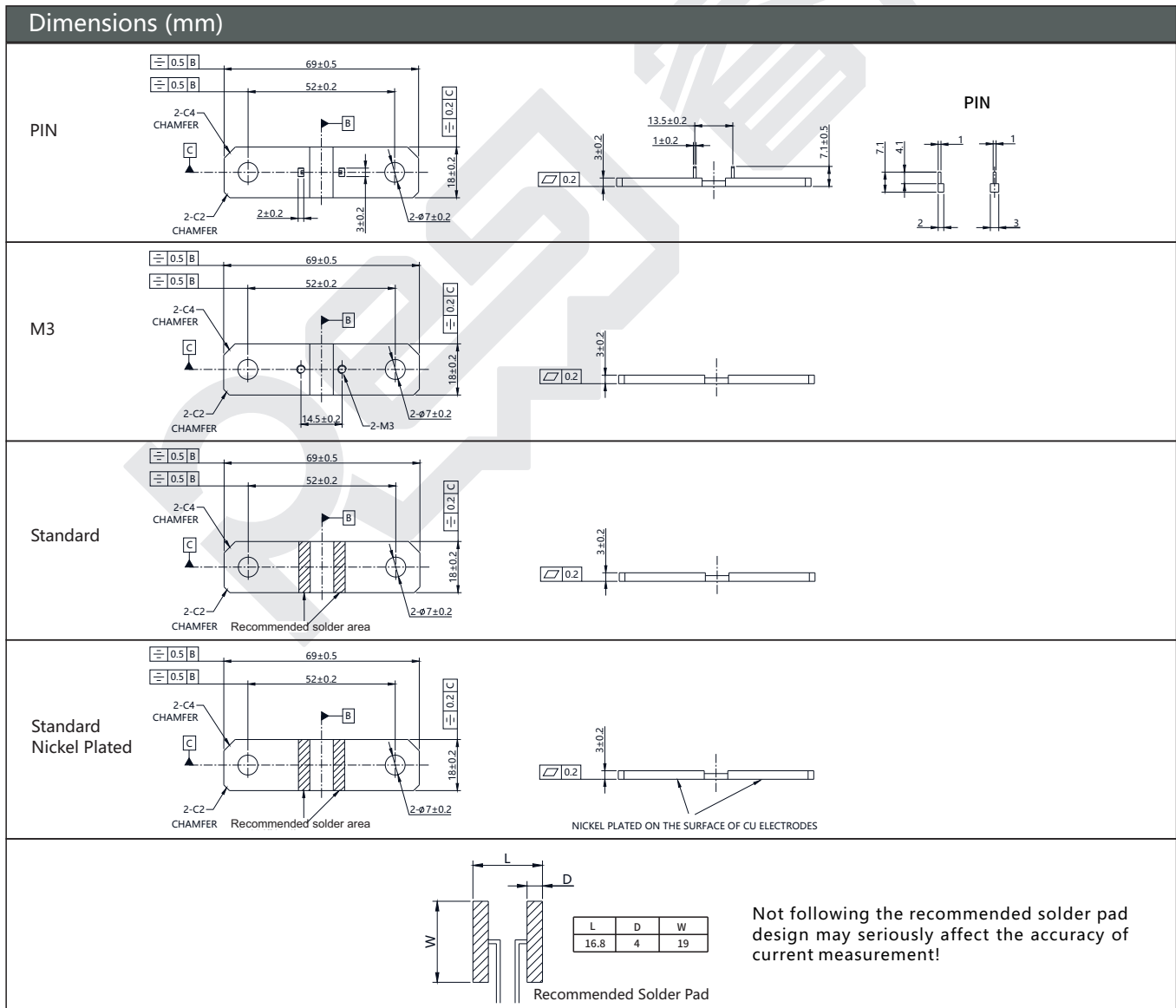

Specifications									
Model	Tolerance	Resistance	TCR (+20°C Ref)	Rated Current	Current Coefficient*	Rated Power	Inductance	Structure	Weight
ARCS6918DL100A9	±0.5%	100μΩ	100ppm/°C (+20°C~+175°C) 175ppm/°C (-55°C~+20°C)	500A	<7ppm/A	25W	<3nH (20KHz)	PIN	35g
ARCS6918FL100A9	±1%								
ARCS6918GL100A9	±2%								
ARCS6918JL100A9	±5%								
ARCS6918DL100B9	±0.5%		100ppm/°C (+20°C~+175°C) 175ppm/°C (-55°C~+20°C)					M3	
ARCS6918FL100B9	±1%								
ARCS6918GL100B9	±2%								
ARCS6918JL100B9	±5%								
ARCS6918DL100S9	±0.5%		50ppm/°C (+20°C~+175°C) 100ppm/°C (-55°C~+20°C)					Standard	
ARCS6918FL100S9	±1%								
ARCS6918GL100S9	±2%								
ARCS6918JL100S9	±5%								
ARCS6918DL100SN	±0.5%		100ppm/°C (+20°C~+175°C) 150ppm/°C (-55°C~+20°C)					Standard Nickel plated*	
ARCS6918FL100SN	±1%								
ARCS6918GL100SN	±2%								
ARCS6918JL100SN	±5%								
ARCS6918DL100S4	±0.5%	100ppm/°C (+20°C~+175°C) 150ppm/°C (-55°C~+20°C)	Nickel plated terminal*						
ARCS6918FL100S4	±1%								
ARCS6918GL100S4	±2%								
ARCS6918JL100S4	±5%								

\*( $R_1 - R_2$ )/[( $I_1 - I_2$ )\* $R_0$ ]( $R_1$ : 2/3 times rated current, 10 min;  $R_2$ : 1/10 times rated current, 10 min;  $R_0$ : Initial resistance;  $I_1$ : 2/3 times rated current;  $I_2$ : 1/10 times rated current.)  
 \*Full nickel plating is the whole nickel plating, including the resistive alloy part, can completely prevent resistive alloy part from the oxidation, but the TCR performance is slightly reduced; half nickel plating type is partial nickel plating, the resistive alloy part is not nickel plated but only the copper terminal.

Performance		
Test	Test method	Test limits
Thermal Shock	-55°C/+155°C, 1000cycles, 15minutes each	ΔR ≤ ±0.5%
Short-Time Overload	5 times rated power, 5 seconds	ΔR ≤ ±0.5%
Low Temp.Storage	-55 °C for 24 hours	ΔR ≤ ±0.5%
High Temp.Exposure	170 °C for 1000 hours	ΔR ≤ ±1.0%
Humidity Resistance	+85 °C, 85% RH 0.1 times rated power, 1000 hours	ΔR ≤ ±0.5%
Moisture Resistance	100G 6mS, 5 times	ΔR ≤ ±0.5%
Vibration	Frequency varied 10Hz to 2000Hz in 1minute, X-Y-Z direction, 12 hours	ΔR ≤ ±0.5%
Load Life Stability	Rated power, 70 °C, 1.5 hours on, 0.5 hours off, 1000 hours	ΔR ≤ ±1.0%

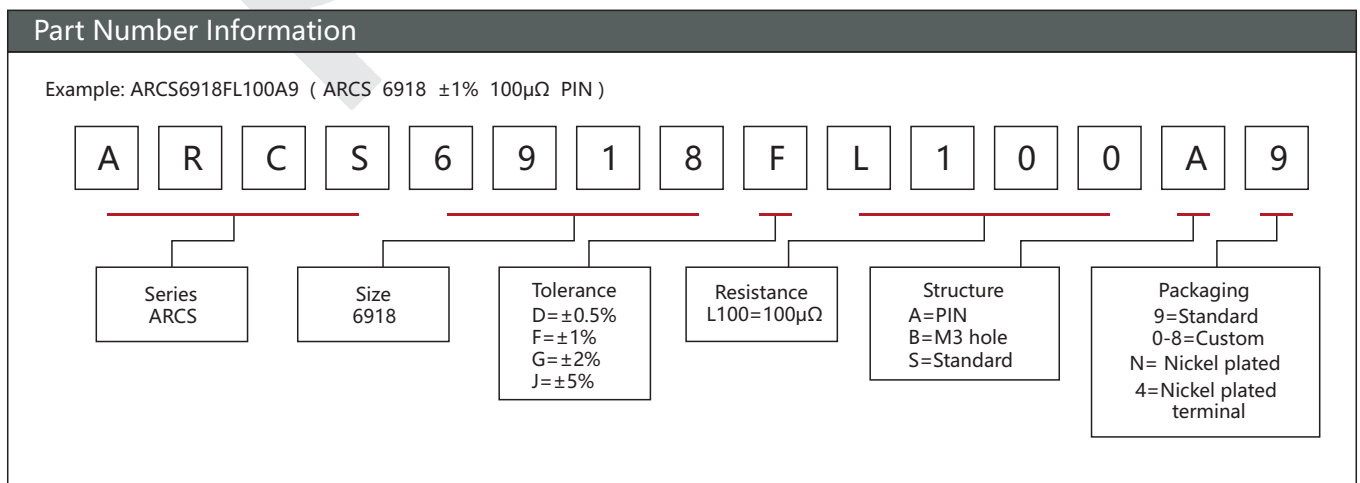

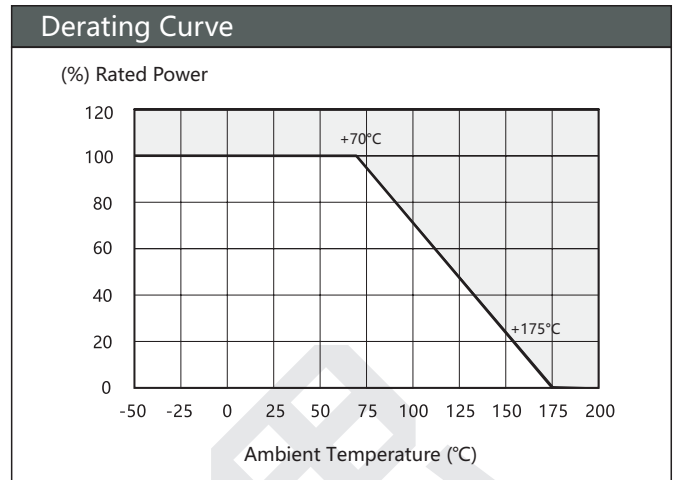
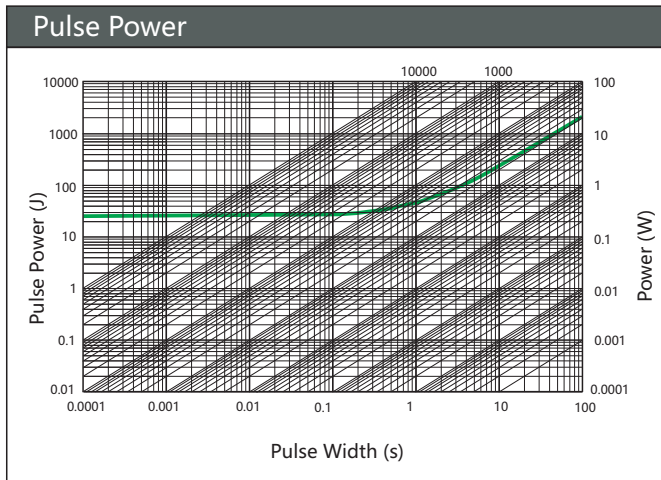

### Safe Storage

- (1) The shunt should be stored at a temperature of 5 to 35 °C, humidity <60% RH, and the humidity should be kept as low as possible.
- (2) The shunt should be protected from direct sunlight.
- (3) The shunt should be stored in a clean, dry and free of harmful gases environment (hydrogen chloride, sulfuric acid, hydrogen sulfide).
- (4) Wear gloves for installation and storage, to reduce the risk of surface oxidation.
- (5) The shunt can be stored for at least 1 year in original package by following above instructions.

### Installation Suggestions

The recommended installation torque for the M3 threaded hole is 0.4~0.8 N.m.

### Packaging

- (1) 15 pcs./PVC tray, with the pin facing downwards.
- (2) Pack every 4 trays into a bundle (60pcs).
- (3) Place each bundle into an aluminum-foil vacuum bag and vacuum seal it.
- (4) A pair of PE gloves and a pair of cotton work gloves in each bag.
- (5) Product unit weight: 27±5g. Box net weight: 1.62kg. Box gross weight: 2.7kg.
- (6) Outer box size: 370×290×85mm.

