

PEWM3920

High-Precision Low-Inductance Alloy Current Sensing Resistor

| | |
|---------------|-----------------|
| Resistance | 0.2mΩ~1.0mΩ |
| Tolerance | ±0.5% |
| TCR | ±100~±150ppm/°C |
| Rated Current | 89A~244A |

Applications

Automotive Electronics
Precision Power Supply
Sorting & Formation of Battery
Electric Tools
Medical Equipment

**Better Solution for Sustainable
High End Manufacturing**

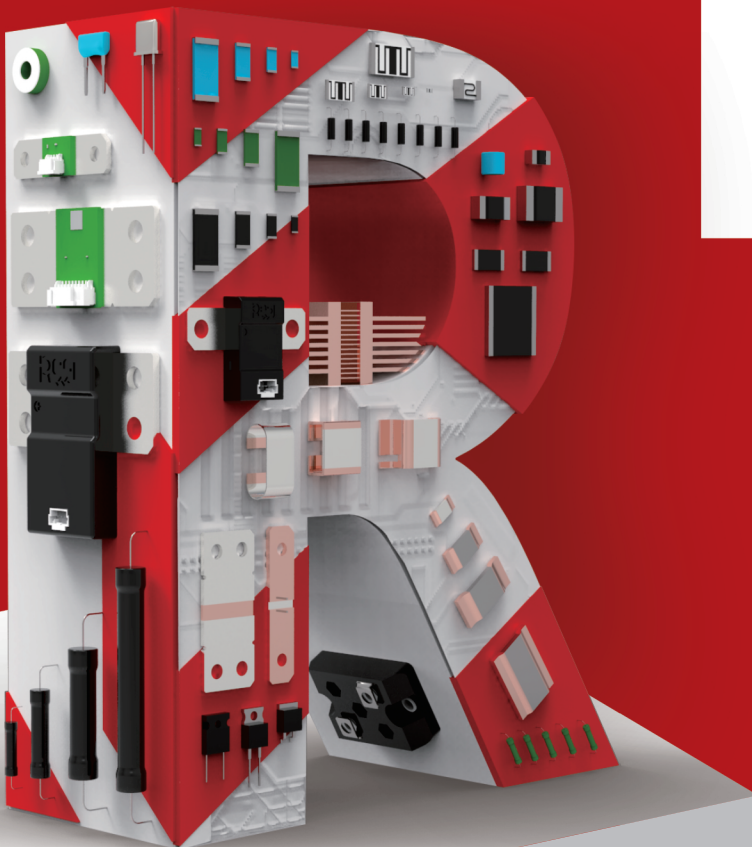

Low-Inductance Alloy Current Sensing Resistor “Trimming Free” Technology, High Precision, Reliability

Introduction

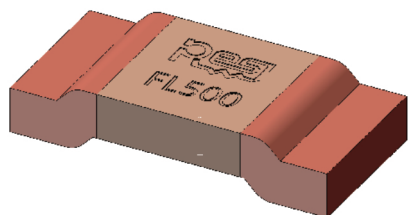

PEWM3920 series is based on a precision resistive alloy, welded by a specialized electron beam welding equipment. Both resistive alloy and welding equipment are independently designed and manufactured by C&B Electronics. Because of controlling the consistency of resistive alloys, precision processing ability and efficient welding, PEWM3920 achieves a maximum target tolerance of $\pm 0.5\%$ after stamping without trimming. TCR of PEWM3920 series 0.3~1m Ω within the temperature range of +20 °C to +170 °C is $\leq \pm 100\text{ppm}/^\circ\text{C}$, 0.2m Ω TCR is within $\pm 150\text{ppm}/^\circ\text{C}$. Inductance is $< 3\text{nH}$.

"Trimming Free" technology avoids the loss of rated current caused by trimming and also avoids current accumulation hotspots caused by trimmed notch, greatly improving the reliability of the product. Meanwhile, due to the improvement of welding quality, thermal EMF of the product is significantly reduced, improving its long-term stability.



PEWM3920 series, from raw materials, core equipment, to core processes, achieves independent and controllable production, stable quality, and timely delivery. If the standard specifications cannot meet your needs, please contact our sales for consultation. Resi is committed to providing the best precision resistor solutions to meet the needs of customers in instrumentation, medical equipment, automotive electronics, precision power supplies, testing and measurement equipment and other fields.

Electrical Parameters

| Size | Resistance | Rated Power (+70°C) | Max. Operating Current | Operating Temperature | TCR ppm/°C | Thermal Resistance* | Tolerance % |
|----------|---------------|---------------------|------------------------|-----------------------|---|---------------------|-------------------------------------|
| PEWM3920 | 0.2m Ω | 12W | 244A | -55°C~+170°C | $\leq \pm 150$ (+20°C~+170°C, 20°CRef) | 3.6°C/W | ± 0.5 ± 1.0 ± 5.0 |
| PEWM3920 | 0.3m Ω | 10W | 182A | -55°C~+170°C | $\leq \pm 100$ (+20°C~+170°C, 20°CRef) | 3.8°C/W | ± 0.5 ± 1.0 ± 5.0 |
| PEWM3920 | 0.5m Ω | 9W | 134A | -55°C~+170°C | $\leq \pm 100$ (+20°C~+170°C, 20°CRef) | 6.3°C/W | ± 0.5 ± 1.0 ± 5.0 |
| PEWM3920 | 1.0m Ω | 8W | 89A | -55°C~+170°C | $\leq \pm 100$ (+20°C~+170°C, 20°CRef) | 12.6°C/W | ± 0.5 ± 1.0 ± 5.0 |

* Thermal Resistance: Refer to the internal thermal resistance between the center of the resistive alloy and the copper electrode. As the heat dissipation efficiency is influenced by operating environment, copper bus bars, PCB design, etc., this parameter is only for reference.

Applications

Inductance of PEWM3920 current sensing resistors is less than 3nH, suitable for AC, DC low and high frequency sampling circuits.

Dimensions

Unit: mm

Resistor

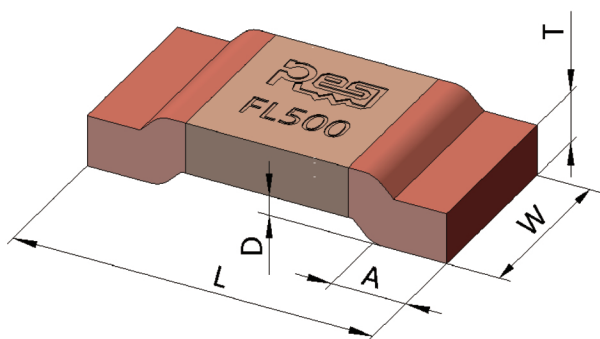

Solder Pad

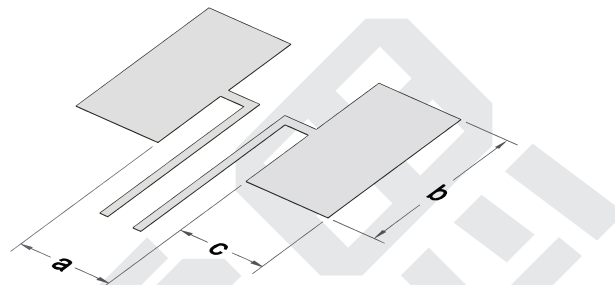

Not following the recommended solder pad design can seriously affect the temperature coefficient measurement results and current sensing accuracy!

| Resistance | L | W | A | T | D | a | b | c | Packaging | Quantity Per Reel | Net Weight |
|------------|----------|---------|---------|---------|---------|---------|---------|---------|-----------|-------------------|------------|
| 0.2mΩ | 10.0±0.3 | 5.2±0.3 | 2.0±0.3 | 1.4±0.2 | 0.5±0.2 | 5.6±0.1 | 6.2±0.2 | 2.7±0.2 | Tape&Reel | 2000pcs | 0.65±0.1g |
| 0.3mΩ | 10.0±0.3 | 5.2±0.3 | 2.0±0.3 | 1.3±0.2 | 0.5±0.2 | 5.6±0.1 | 6.2±0.2 | 2.7±0.2 | Tape&Reel | 2000pcs | 0.59±0.1g |
| 0.5mΩ | 10.0±0.3 | 5.2±0.3 | 2.0±0.3 | 0.8±0.2 | 0.5±0.2 | 5.6±0.1 | 6.2±0.2 | 2.7±0.2 | Tape&Reel | 2000pcs | 0.36±0.1g |
| 1.0mΩ | 10.0±0.3 | 5.2±0.3 | 2.0±0.3 | 0.4±0.2 | 0.5±0.2 | 5.6±0.1 | 6.2±0.2 | 2.7±0.2 | Tape&Reel | 2000pcs | 0.18±0.05g |

Part Number Information

Example: PEWM3920FL500K9 (PEWM 3920 ±1.0% 0.5mΩ ±100ppm/°C Standard)



For higher/lower resistance, tighter tolerance, higher power, lower TCR and larger size, please contact us.

Performance

| Test | Test Method | Standards | Typical | Max. |
|---------------------------|---|--|--|---------------------------|
| High Temperature Storage | 1000h@+170°C, unpowered | AEC-Q200 TEST 3 MIL-STD-202 Method 108 | $\Delta R \leq \pm 0.5\%$ | $\Delta R \leq \pm 1.0\%$ |
| Thermal Shock | -55°C, 15min~ambient temperature<20s~+155°C, 15min, 1000 cycles | AEC-Q200 TEST 16 MIL-STD-202 Method 107 | $\Delta R \leq \pm 0.1\%$ | $\Delta R \leq \pm 0.5\%$ |
| Bias Humidity | +85°C, 85%RH, powered no less than 10% rated power for 1000h | AEC-Q200 TEST 7 MIL-STD-202 Method 103 | $\Delta R \leq \pm 0.2\%$ | $\Delta R \leq \pm 0.5\%$ |
| Load Life | 2000h @ +70°C, rated power, 90min on, 30min off +70°C refers to terminal temperature | AEC-Q200 TEST 8 MIL-STD-202 Method 108 | $\Delta R \leq \pm 0.5\%$ | $\Delta R \leq \pm 1.0\%$ |
| Resistance to Solvent | Immerse in solvent for 3 min and wipe 10 times. Three cycles of three solvents. Dry at ambient temperature after cleaning | AEC-Q200 TEST 12 MIL-STD-202 Method 215 | Clear marking. No visible damage | |
| Mechanical Shock | Half Sine Wave, peak acceleration 100g's, pulse duration 6ms, 3 times in each of six directions, on three different axes | AEC-Q200 TEST 13 MIL-STD-202 Method 213 | $\Delta R \leq \pm 0.01\%$ | $\Delta R \leq \pm 0.2\%$ |
| Vibration | 10-2KHz, 5g's, 20min/cycle, 12 cycles in each directions of X Y Z | AEC-Q200 TEST 14 MIL-STD-202 Method 204 | $\Delta R \leq \pm 0.01\%$ | $\Delta R \leq \pm 0.2\%$ |
| Resistance to Solder Heat | +260°C tin bath for 10s | AEC-Q200 TEST 15 MIL-STD-202 Method 210 | $\Delta R \leq \pm 0.2\%$ | $\Delta R \leq \pm 0.5\%$ |
| Solderability | +245°C tin bath for 3s | AEC-Q200 TEST 18 IEC 60115-1 4.17 | No visible damage. 95% minimum coverage | |
| TCR | +20°C and +170°C, +20°C Ref. | AEC-Q200 TEST 19 IEC 60115-1 4.8 | Refer to tested curve, 0.2mΩ: max. value $\leq 150\text{ppm}/^\circ\text{C}$ 0.3~1mΩ: max. value $\leq 100\text{ppm}/^\circ\text{C}$ | |
| Substrate Bending | 2mm. Duration: 60s. | AEC-Q200 TEST 21 AEC-Q200-005 | $\Delta R \leq \pm 0.1\%$ | $\Delta R \leq \pm 0.5\%$ |
| Short Time Overload | 5x rated voltage, 5s | IEC 60115-1 4.13 | $\Delta R \leq \pm 0.1\%$ | $\Delta R \leq \pm 0.5\%$ |
| Low Temperature Storage | -55°C for 96h, unpowered | IEC 60068-2-1 | $\Delta R \leq \pm 0.1\%$ | $\Delta R \leq \pm 0.5\%$ |
| Moisture Resistance | Apply T=24 h/cycle, zero power, method 7a and 7b are not required | MIL-STD-202 Method 106 | $\Delta R \leq \pm 0.1\%$ | $\Delta R \leq \pm 0.5\%$ |

Temperature Coefficient of Resistance Test Curve

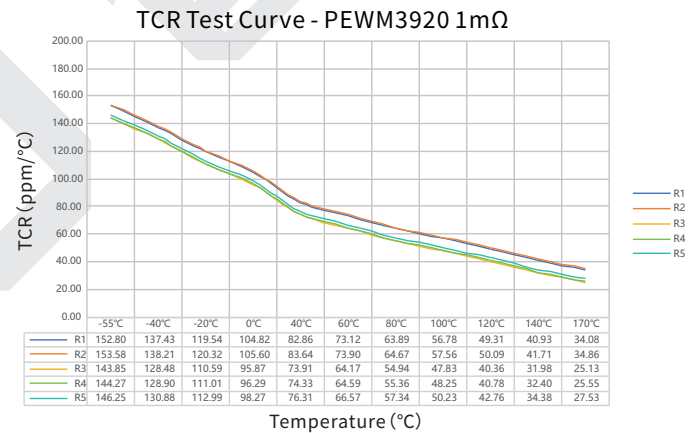
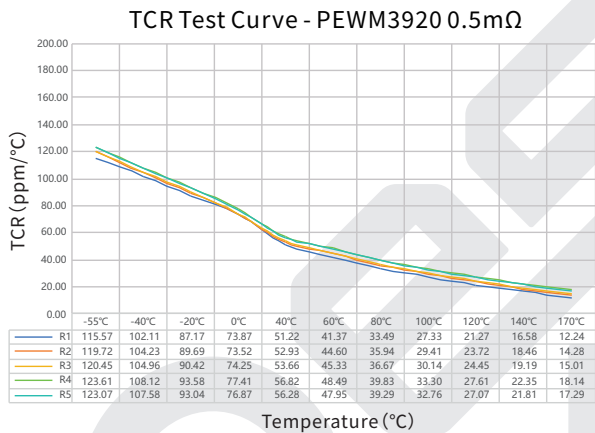
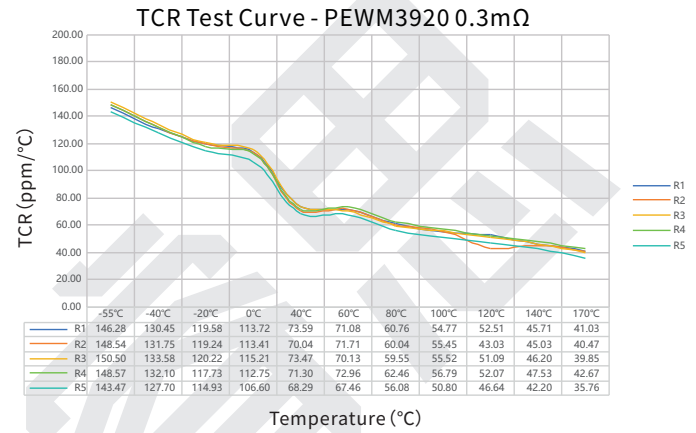
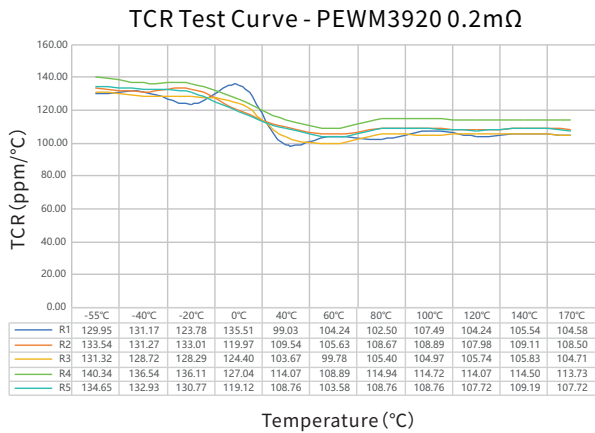

Derating Curve

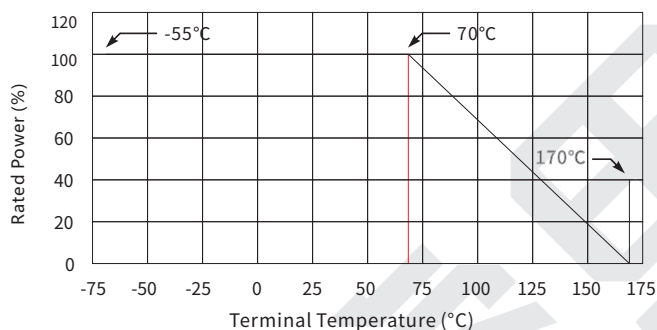

Reflow Soldering Profile

Resistor Surface Temperature:
 Pre-Heat: +150°C~+190°C, 60~120sec.
 Reflow: Above +220°C, 90~150sec.
 Applicable Solder Composition: Sn-Ag-Cu

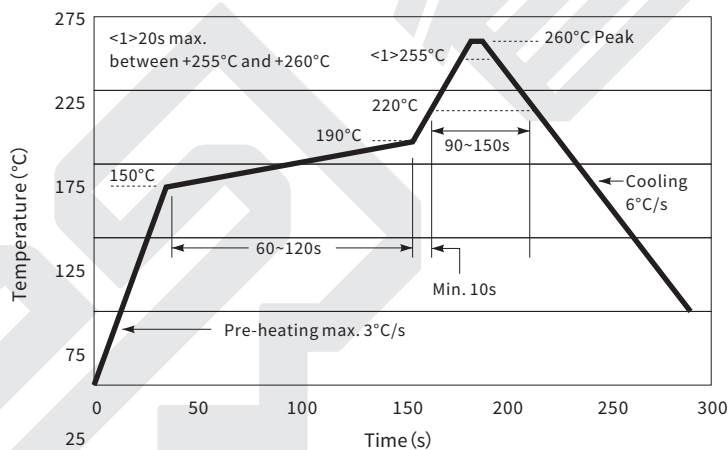

Maximum Pulse Energy Curve

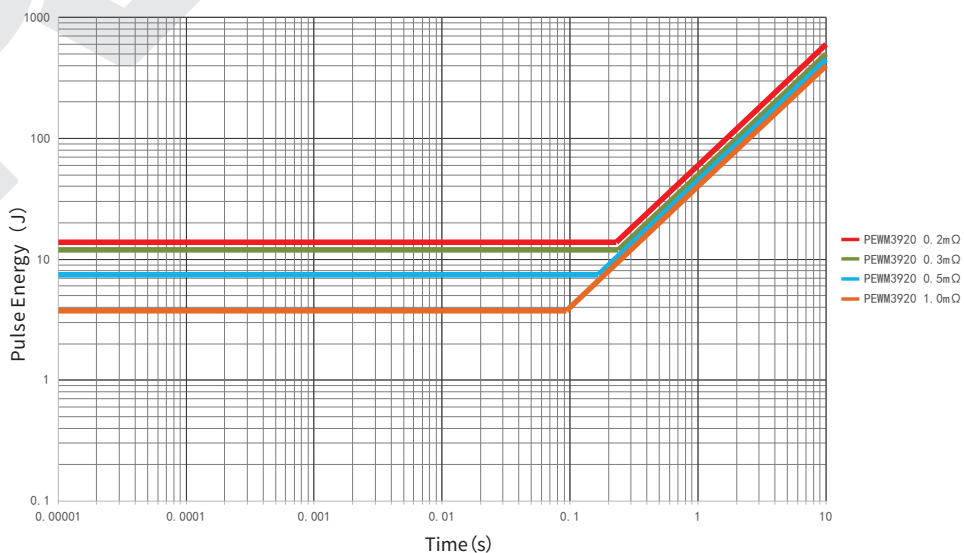

Construction

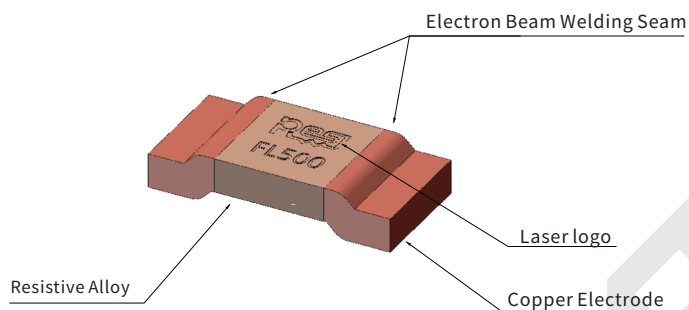

Marking

The first line (four digits) represents brand. The second line (five digits) represents tolerance and resistance.

| Size | Illustration | Demonstration |
|------|--------------|---------------|
|------|--------------|---------------|

| | | |
|------|--|---|
| 3920 |  | RESI: Brand F: Tolerance L500: Resistance |
|------|--|---|

Storage Instructions

- (1) Resistors should be stored at a temperature of 5 to 35 °C, with a humidity of <60% RH. The humidity should be kept as low as possible.
- (2) Resistors should be protected from direct sunlight.
- (3) Resistors should be stored in a clean and dry environment free of harmful gases (HCl, Sulfuric acid, H₂S, etc.)
- (4) Do not move the resistor from the packaging unless use it.
- (5) Under the above storage conditions, the resistor can be stored for at least 1 year.

Usage Suggestions

- (1) Please protect the surface of the resistor during use. Prevent defects such as scratches, bumps, and oil stains on the surface.
- (2) Do not use sharp tweezers to move the resistor. Scratches on the surface can cause resistance drift and resistor failure.
- (3) When installing and using resistors, avoid the impact of mechanical stress on the resistor.
- (4) The long-term operating power of resistors should be \leq rated power to avoid resistance drift caused by long-term overload.
- (5) Please refer to the derating curve when operating under high temperature conditions or poor heat dissipation environment.
- (6) If the operating conditions exceed the pulse specified in the pulse curve, a systematic evaluation is required.
- (7) If the resistor is not used after being moved from the packaging, it should be stored under vacuum to avoid risks such as poor welding caused by oxidation of the resistor.

Packaging

Tape Specifications

Unit: mm

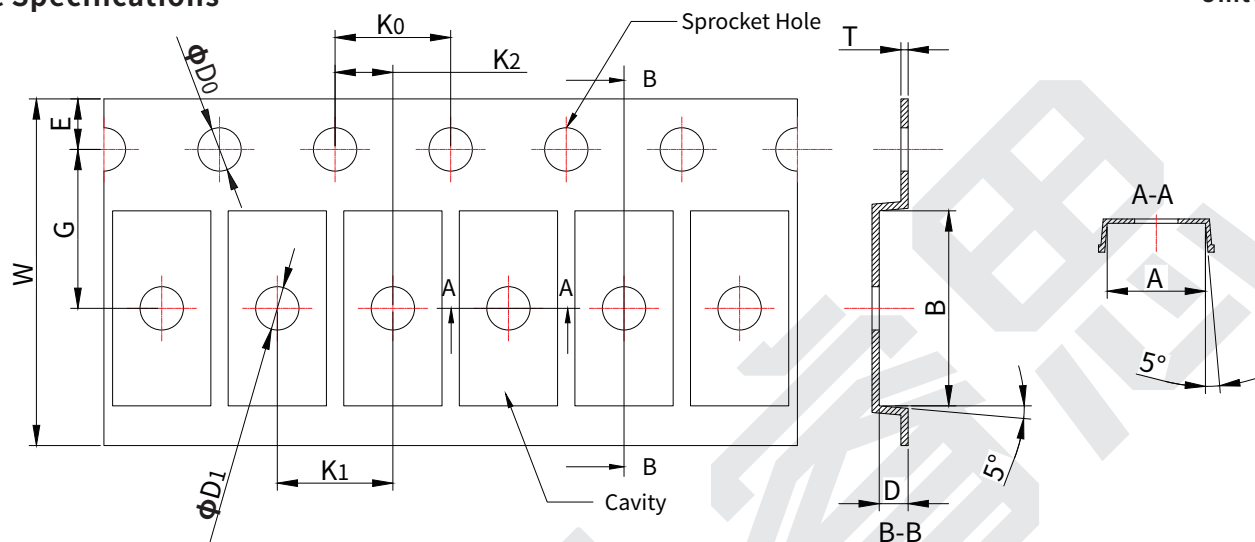

| Resistance | A | B | φD ₀ | φD ₁ | K ₀ | K ₁ | K ₂ | E | G | W | D | T |
|------------|---------|----------|-----------------|-----------------|----------------|----------------|----------------|----------|----------|-----------|---------|----------|
| 0.2mΩ | 5.5±0.2 | 10.5±0.2 | 1.5±0.1 | 1.5±0.1 | 4.00±0.1 | 8.00±0.1 | 2.00±0.1 | 1.75±0.1 | 7.50±0.1 | 16.00±0.3 | 2.7±0.1 | 0.3±0.05 |
| 0.3mΩ | 5.5±0.2 | 10.5±0.2 | 1.5±0.1 | 1.5±0.1 | 4.00±0.1 | 8.00±0.1 | 2.00±0.1 | 1.75±0.1 | 7.50±0.1 | 16.00±0.3 | 2.1±0.1 | 0.3±0.05 |
| 0.5mΩ | 5.5±0.2 | 10.5±0.2 | 1.5±0.1 | 1.5±0.1 | 4.00±0.1 | 8.00±0.1 | 2.00±0.1 | 1.75±0.1 | 7.50±0.1 | 16.00±0.3 | 1.5±0.1 | 0.3±0.05 |
| 1.0mΩ | 5.5±0.2 | 10.5±0.2 | 1.5±0.1 | 1.5±0.1 | 4.00±0.1 | 8.00±0.1 | 2.00±0.1 | 1.75±0.1 | 7.50±0.1 | 16.00±0.3 | 1.5±0.1 | 0.3±0.05 |

Reel Specifications

Unit: mm

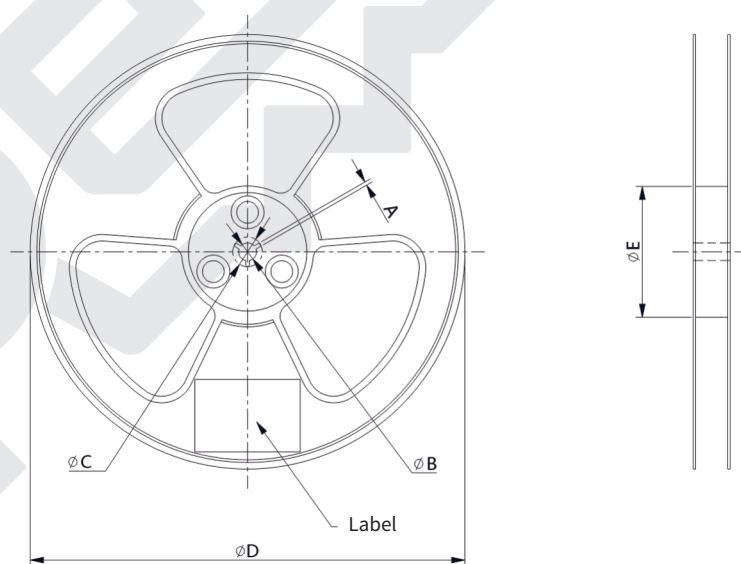

| A | φB | φC | φD | φE |
|----------|----------------|-----------|-------|-------|
| 1.5 Min. | 13.0 +0.5/-0.2 | 20.2 Min. | 330±2 | 100±2 |

Packaging

- (1) 2000 pcs. resistors are packed in a tape and wrapped in a reel;
- (2) Every 2 reels are packed by a cardboard sleeve case. The size of the cardboard is 335mm*340mm*37mm;
- (3) Place every 3 cases into a box (12000 pcs. / box);
- (4) Box size: 350mm*370mm*165mm.

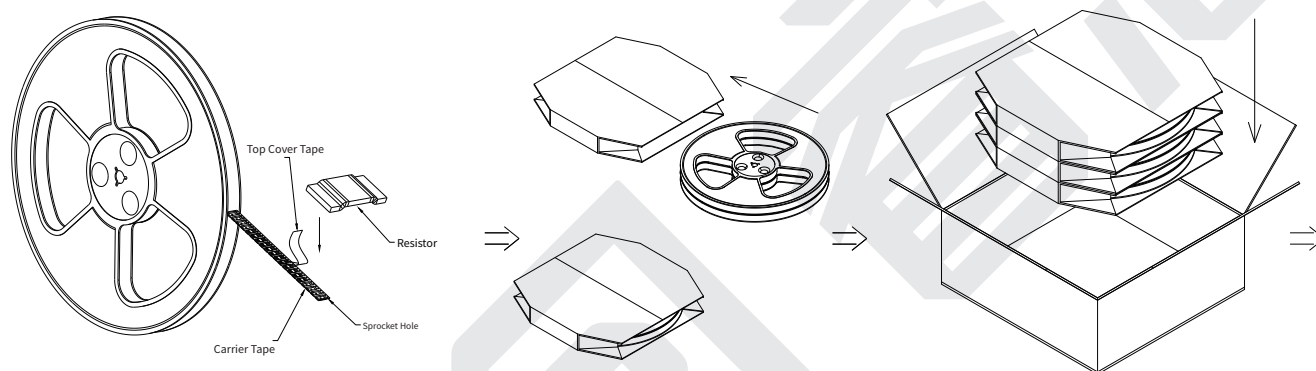

1. 2000 pcs. resistors are packed in a tape and wrapped in a reel.

2. Every 2 reels are packed by a cardboard sleeve case. The size of the cardboard is 335mm*340mm*37mm;

3. Place every 3 cases into a box (12000 pcs. / box).

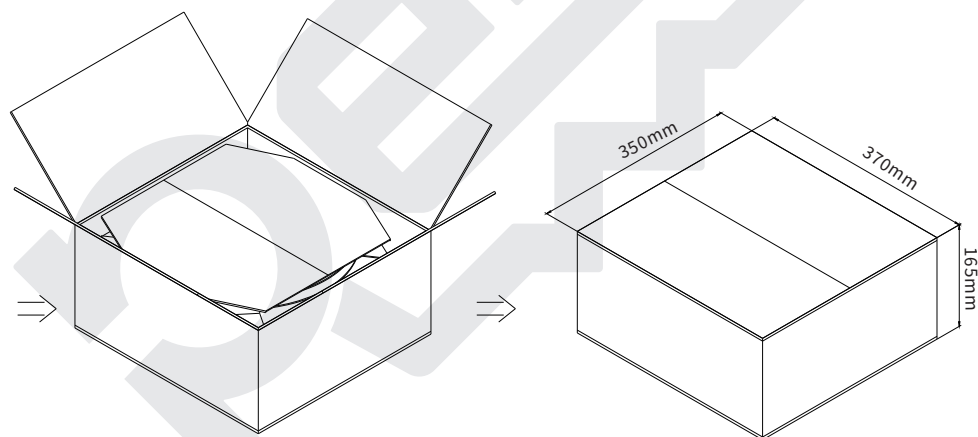

4. Bubble wrap or EPE should be placed to prevent products from shaking or vibration.

5. Box size: 350mm*370mm*165mm

Popular Part Numbers

| Part Number | Size | Tolerance | Resistance | TCR | Power | Max. Operating Current |
|-----------------|------|-----------|------------|-------------|-------|------------------------|
| PEWM3920DL200R9 | 3920 | ±0.5% | 0.2mΩ | ≤±150ppm/°C | 12.0W | 244A |
| PEWM3920DL300K9 | 3920 | ±0.5% | 0.3mΩ | ≤±100ppm/°C | 10.0W | 182A |
| PEWM3920DL500K9 | 3920 | ±0.5% | 0.5mΩ | ≤±100ppm/°C | 9.0W | 134A |
| PEWM3920D1L00K9 | 3920 | ±0.5% | 1.0mΩ | ≤±100ppm/°C | 8.0W | 89A |
| PEWM3920FL200R9 | 3920 | ±1.0% | 0.2mΩ | ≤±150ppm/°C | 12.0W | 244A |
| PEWM3920FL300K9 | 3920 | ±1.0% | 0.3mΩ | ≤±100ppm/°C | 10.0W | 182A |
| PEWM3920FL500K9 | 3920 | ±1.0% | 0.5mΩ | ≤±100ppm/°C | 9.0W | 134A |
| PEWM3920F1L00K9 | 3920 | ±1.0% | 1.0mΩ | ≤±100ppm/°C | 8.0W | 89A |
| PEWM3920JL200R9 | 3920 | ±5.0% | 0.2mΩ | ≤±150ppm/°C | 12.0W | 244A |
| PEWM3920JL300K9 | 3920 | ±5.0% | 0.3mΩ | ≤±100ppm/°C | 10.0W | 182A |
| PEWM3920JL500K9 | 3920 | ±5.0% | 0.5mΩ | ≤±100ppm/°C | 9.0W | 134A |
| PEWM3920J1L00K9 | 3920 | ±5.0% | 1.0mΩ | ≤±100ppm/°C | 8.0W | 89A |

Revision

| Version | Revised Content | Date | Approver |
|---------|--|------------|----------|
| V0 | Initial Issue | 2022.07.28 | LWW |
| V1 | Add TCR test curve | 2022.10.28 | LWW |
| V2 | Add a new resistance 0.3mR; Change datasheet to the new template | 2023.08.06 | LWW |
| V3 | Add a new resistance 0.2mR, Change datasheet to the new template; Add the dimensions of solder pad; Update the test results of vibration and mechanical shock; Add the packaging specifications | 2024.03.13 | LWW |

Disclaimer

All products, datasheets and data can be changed without prior notice.

C&B Electronics Shenzhen CO., LTD., its affiliates, distributors, employees, and any other person acting on its behalf (collectively referred to as "C&B Electronics") shall not bear any legal responsibility for any errors, inaccuracies, or incompleteness of information related to the product disclosed under this agreement or other disclosures.

Product datasheet does not constitute an extension or revision of the purchase terms and conditions in C&B Electronics, including but not limited to the warranties under this agreement.

Unless specified in the purchase terms and conditions, C&B Electronics makes no guarantees, representations or warranties.

To the maximum extent permitted by applicable laws, C&B Electronics hereby makes the following disclaimer:

- (1) All liabilities arising from the use of the product;**
- (2) Including but not limited to all liabilities arising from special, indirect or incidental damages;**
- (3) All implied warranties, including warranties of suitability for special purposes, non infringement possibility, and marketability.**

The information provided in the datasheet and parameter tables may vary in different applications, and the performance of the product may change over time. The recommended application instructions for the product are based on C&B Electronics' understanding and experience of typical requirements. Customers are obligated to verify whether the product is suitable for a specific application based on the parameters provided in the datasheet. Before officially installing or using the product, you should ensure that you have obtained the latest version of relevant information, which can be obtained through the website: resistor.today.

The signing of this agreement does not constitute an express, implied or other form of license related to all intellectual property rights of C&B Electronic Products.

Unless explicitly stated, the products listed in this agreement are not applicable to lifesaving or life sustaining products. In the absence of a clear indication, the customer shall bear all risks caused by unauthorized use of the above products and agree to fully compensate C&B Electronics for all losses caused by such sales or use. For written product terms for such special applications, please contact authorized personnel from C&B Electronics to obtain.

The names and markings on the listed products may be trademarks owned by others.